



**USAID**  
FROM THE AMERICAN PEOPLE

# COMMUNITY ENGAGEMENT GUIDE

## MAJESTY GARDENS REGULARIZATION



# INTRODUCTION

## Objectives of Community Engagement

The broad mission of a community regularization initiative is to increase safe, reliable, and legal electricity access in communities characterized by a high number of illegal connections. These activities play a dual role of improving the utility company's bottom line, while providing the social benefit of increasing safe and reliable electricity access to typically disadvantaged social groups.

This community engagement manual will provide the background, resources, and structure for effectively and efficiently engaging with community members and other community engagement stakeholders around this type of programming.

The manual will assist the reader (intended to be someone supporting the Majesty Gardens community engagement program) to understand community engagement basics and residential electricity fundamentals as well as to provide specific information on Jamaican tariff structure and the Readyboard program in Majesty Gardens.

## Jamaica Public Service Co. Ltd. (JPS)

### Overview

Jamaica Public Service Company Limited (JPS) is an electric utility company which engages in the generation, transmission, and distribution of electricity. The company serves residential, commercial, and industrial customers through a network of offices and operational facilities. It owns and operates generating units, substations, and transmission and distribution lines.

In recent years, JPS has had difficulties in reducing non-technical losses (primarily electricity theft, but also non-payment by customers and errors in accounting and record-keeping), a portion of which stem from illegal connections in informal settlements, inner-city communities, and low income areas. Total system losses currently stand at approximately 26.5% and are driven by both technical losses (power losses due to natural power dissipation, poor systems planning, and equipment inefficiencies) of 8.6%, and non-technical losses (power losses due to commercial and consumer behavior) of 17.9%, primarily due to power theft. It is estimated that JPS may provide service to approximately 180,000 unauthorized residential customers, leading to significant losses to the utility given that consumers that do not pay for power tend to consume higher than average amounts due to a lack of price signal.

An estimated 5% to 10% of these 180,000 illegal connections originate in sub-standard dwellings, which cannot legally be wired for electricity, due to the requirements of the Jamaican Electric Code. As a result, currently there is no permissible electricity option for these households, meaning many engage in illegal connections and dangerous wiring alternatives to utilize power in their homes. While no statistics are collected on fires, fatalities, or injuries caused by illegal, poor wiring, stories of house fires attributable to subpar wiring are abundant.

### Contact Numbers and Offices

6 Knutsford Boulevard

Kingston 5 Jamaica, W.I.

Phone: 1-888-935-5577 or 1-888-225-5577

## Jamaica Social Investment Fund (JSIF)

## Overview

The Jamaica Social Investment Fund (JSIF) is a limited liability company incorporated under The Companies Act of Jamaica. It was established in 1996 as a component of the Government of Jamaica's (GoJ's) national poverty alleviation strategy and is funded by the GoJ and international donors. JSIF was designed primarily to channel resources to small-scale community based projects, but over the years projects have grown in scale and complexity in response to national development priorities. It leads a number of community renewal programs in tandem with other development partners.

Currently JSIF and JPS collaborate through a Memorandum of Understanding (MOU) that supports the Integrated Community Development Project, a multi-faceted initiative financed by the Government of Jamaica and international development partners to improve access to public services for residents in 18 of the most vulnerable and volatile communities across the island. In particular, JPS and JSIF are focusing on 10 Corporate and Rural area communities, including Majesty Gardens, to reduce non-technical losses and improve electricity service.

## Contact Numbers and Offices

Ground Floor; The Dorchester

11 Oxford Road (Entrance on Norwood Avenue)

Kingston 5 Jamaica, W.I.

Phone: 1(876) 968-4545 or 1-888-991-2356/7

## Readyboard Project

The Readyboard project is a pilot project implemented by JPS, USAID and JSIF, which will assist residents of the Majesty Gardens community in Kingston, Jamaica to access legal electricity via a readyboard and pre-payment meter as a safer and affordable alternative to illegal power (see Metering Electricity and Using a Readyboard for more detail).

## Partners and Funding

- USAID: provide assistance related to community engagement and demand side management best practice as well as technical and engineering design support on the readyboard specification and installation; provide the readyboard materials for 400 households; conduct pre and post project surveys, and capture program impacts and lessons learned in a final report.
- JPS: provide storage and transportation for the readyboard materials during the project period; lead customer registration and service follow-up queries; fund and build out the infrastructure needed for the readyboard installation (pre-paid meters, wires, and maypoles)
- JSIF: lead the socialization and community engagement programming with the Majesty Gardens residents; own the readyboard materials and oversee their assembly, installation, and handover.
- UTech: provide students to assemble and test the readyboards; store smaller batches of the readyboards on campus.

## Schedule for Installation

- September – October 2016 – Readyboard materials delivered to JPS & JSIF
- Mid October 2016 – Readyboard materials assembled by UTech
- August 2016 & Ongoing – Customer registration and sign-up
- October 2016 – Readyboard socialization and energy efficiency programming led by JPS & JSIF
- October 2016 – Inspection and safety demonstrations from GEI

- End of October 2016 thru mid-December – Installation in residents homes in sets of 50
- November 2016 – Follow up and customer engagement
- December 2016 – JPS to electrify the Readyboards
- December 2016 – Removal of the illegal wiring/hook-ups

# THE BASICS OF COMMUNITY ENGAGEMENT

## Community Engagement Stages

### Connecting with the Community

A key element to engaging a community in a regularization program is having a deep understanding of the local context that makes up the community. Understanding how residents are employed, what residents do in their free time, and the experiences that residents value in their day to day life can have profound effects on how the message of regularization is communicated. For example, knowing the working habits of a community can determine how an implementing team will design and implement community engagement activities. In areas where residents work long periods away from home it can be difficult to accurately gauge the population and even more difficult to hold community meetings where a majority of residents can be present.

Surveys, focus groups, and one-on-one interviews are important to determine the structure and culture of a community and, accordingly, feed into the design of the community engagement activities.

#### *Develop Profile of the Communities and Resident Associations*

At a high level, a profile for the community should be created, covering publicly available information such as location and local infrastructure, government demographic information, previous customer data (if available), crime data, and any comments available from the Minister of Parliament (or other government official) for the community. Additionally, working with implementing partners who may already be active in the area (e.g. National Housing Trust, National Water Commission, Community Development Council, Social Development Corporation) to collect information can be invaluable for an initial community profile. While this research may not provide the detailed information that is required to customize community engagement activities, it can help in designing the survey process and identify knowledge gaps.

#### *Surveying the Community*

A formal survey of the residents in the community can provide significant benefits related to understanding the community's capacity for payment, typical profile of electrical appliance ownership and usage, reception to regularized electricity, data on daily habits and behaviors, and understanding of electricity. Each of these areas are key for engaging with the community, as outlined below:

- **Capacity for payment:** A resident's monthly income is an important metric for determining how well residents will be able to pay bills and how electricity should be provided (e.g. pre- or post-paid meters) as well as the need of social tariffs, usage caps, and debt forgiveness techniques for transitioning to a legal system. Important aspects are amount of income and regularity or seasonality of income, particularly pertinent for the application of pre-paid systems. Income should be compared to the expected cost of an individual's electricity consumption. Attention should be paid to the amount that residents state they are willing to pay for the amount they currently use (measured by the combination of appliances each resident owns and the amount of time they use the appliances) given their current budget, as this will illustrate any lifestyle changes that will have to be in order for customers to adapt to electricity bills. It is also important to get a determination of how much residents may be willing to pay for legal electricity and illegal electricity. Illegal providers can make regularization programs more difficult by cutting costs, decreasing the quality of legal power, or even damaging equipment provided by a utility for customers.

- **Electrical appliances ownership:** An accurate inventory of a community’s ownership of electrical appliances along with information on how those appliances are used on a daily basis allows for estimations of residents’ future bills. Included in this inventory should be the number of appliances, the age of TVs, freezers, and refrigerators if they are owned, and usage on a daily basis. While only an estimate, given the hard-to-measure factors such as reduced demand from introducing a price for electricity, having insight into a resident’s future electrical bill provides transparency and helps residents prepare earlier in the process. It can also help guide stakeholders on areas to prioritize for demand side management outreach.
- **Receptivity to regularization:** A community’s reception to regularization typically goes hand in hand with their perceptions of illegal electricity. If the illegal substitute to legal electricity is providing safe and reliable service at a fraction of the cost, it would be difficult to convince residents to regularize. Fortunately, legal electricity provides better safety and higher quality than illegal connections, with the added benefits of decreasing arrests and service cuts, providing professional customer service, and reducing the wear on appliances. It is also important to determine the costs of illegal connections as residents typically pay for the illegal connection through “hook-up” charges. Determining the residents’ awareness of these facts can be helpful in marketing programs to the community. As mentioned previous, any information on the strength of illegal providers should be gathered, although it is understood that this information may not be shared willingly by customers. Questions such as “How much do you currently pay for electricity?” or “Do you hook up your own electricity or is there someone who does it for you?” can help reveal information on illegal service provision.
- **Habits and behaviors:** Collecting information on habits, behaviors, and preferences with respect to their use of energy is critically important in customizing programs to the community. For example, in Majesty Gardens most residents’ value leaving house lights on 24/7 as the light provides safety in an area with very little existing street lighting. As an example, a program to improve public street lighting would allow residents to turn off their lights at night once the community has been regularized, saving large sums on their electricity bills. It is also important to determine how many distinct family groups live under a single roof, with particularly important implications for how a home may be metered given that structure.
- **Electricity understanding:** The “electrical literacy” of the community should be gauged during the survey in order to determine how well residents understand legal electricity services and the cost of specific appliance usage. This information can be used to develop or refine clear and simple explanations of how legal electricity will differ from illegal connections. Knowledge of pre-paid services, less expensive lower-use tariffs, and ancillary benefits of being a JPS customer should be measured and used to design community programming.

### *Assess Local Infrastructure*

One of the difficulties with implementing a regularization program in informal settlements is that formal roads and housing lots are typically non-existent, making the registration of customers and delivery of electricity far more complicated than formal communities. Understanding the physical layout of the community is critical for the development of the rollout plan, and the collection of this information should be done in close coordination with the teams conducting any regularization program roll out. Creating addresses or other markers (such as GPS coordinates or geographic locators) to follow residents through the program is helpful at the outset of the program.

Local infrastructure also includes the structure of personal dwellings and will be used to determine which solutions would be the most effective electrification choice for the given community. In the case of the Readyboard program, the dwellings were unable to support traditional wiring and required the utilization of a readyboard to provide a safe and legal house wiring solution.

After the inspection of the resident’s homes, the technical teams can develop the design of appropriate wiring solutions (traditional or readyboard solutions) as well as an estimation of the material requirements.

## Provide Local Points of Contact

Once the community is aware that a regularization program will likely occur, questions will begin to arise about schedule, billing, and/or customer sign up. Ensuring that the community has a local spokesperson or a dedicated resource at JPS to field inquiries on the regularization program allows JPS to develop trust with the community (see “How to Get Help” on pg. 16). This also allows JPS to maintain a pulse on the community’s perception of the program, and know when to address questions and concerns at a broader forum. JPS Community Facilitators are located and can be accessed at JPS Service Centres located in the Community Renewal Communities. Their office hours are from 8:30am to 4:00pm Mondays to Fridays. However due to field work’s nature, the facilitators may be a way from the office for extended periods. As such, a note is left on the door, advising of their time expected return time.

## Customer Sign-up Process

1. JPS facilitates temporary offices for sign up and contracts at the JPS Service Center in Majesty Gardens
2. The dates for signups is communicated, by Community Facilitators, either by text messaging, flyers, or door to door communication
3. Requirements for Signing Contracts
  - Valid Identification, e.g National Identification , Driver’s License, Passport
  - TRN Number - Tax Registration Number
  - Proof of ownership if available
  - Letter of Authorization form Landlord if customer is a Tennant
  - Customer
4. Assessment of premises to determine if houses can be wired
5. Customer is advised and told to pay contribution to Bill Express
6. Ready Board is installed

## Socialization and Resident Engagement

### Answering Resident Questions & Promotional Material

When responding to questions from community residents, it is helpful to have prepared answers to the frequently asked questions (see Metering Electricity and Using a Readyboard for more detail). Ensure that any promotional materials include these frequently asked questions for those that are unable to ask questions or attend community meetings.

In developing the responses to common questions, community liaisons and utility and NGO employees should play a role in determining the appropriate response ahead of any community meetings in order to ensure that residents are presented with a unified program and do not spread inaccurate information to the community at large.



In addition to answering questions from the community, some activities can be proactively undertaken in order to avoid misunderstandings between stakeholders and residents in the future. For example, in person demonstrations of an example Readyboard were given at a community meeting for residents in Majesty Gardens, allowing a practical illustration of what the capabilities and functions of the wiring solution would be when it was installed in residents' homes. Depending on the community's habits and behaviors, an in-person demonstration may not be as effective as brochures or how-to-guides or vice versa, but a mixture of in person and material communication typically provides the best coverage for addressing resident concerns ahead of time. JPS will begin its engagement with a new community with a "town crier" who will announce a coming community meeting. As the relationship with a community develops, a facilitator from the community becomes more effective. The facilitator's role is to issue flyers combined along with sending text messages. The combination of the two techniques typically drive the best response from the community.

### **Engaging Community Leadership**

Community leadership can have a broad definition, ranging from formal and informal to embedded NGOs and other stakeholders. Whether an individual or an organization, leaders have a disproportionate influence on communities and working with leaders can provide significant benefits to a regularization program. More often than not, community leadership has a well-informed perspective on the primary issues facing the community and is knowledgeable on how people are actively addressing those issues. Of particular value are leaders' perspectives on how the larger community will respond and evaluate what is being done through regularization programs, and can provide critical advice on how to present and message sensitive information to the community.

When working with a leader in the community it is important to confirm that the leader's motives are aligned with the community engagement team's goals. Meeting with leaders to establish the goals of the program prior to making announcements to the community can help to determine the leader's enthusiasm for the project, as well as collect valuable input from the individual (or group) prior to making the program public. When motives are aligned the leader may want to play an active role in the program's messaging or help to advise as the project moves forward, both of which would be strong benefits to the regularization program. If the leader is far less enthusiastic about the program, it may be difficult to work with the individual (or group) in the future and can even lead to resistance from the leader as the project progresses. In the cases where a leader does not share the same vision as program implementers, further guidance on the benefits of the program may be required or the implementers may need to identify a new leader to champion the program.

In many areas where regularization programs are implemented, concurrent programs are initiated in energy consumption and conservation, targeting customers with notable energy losses, bad consumer habits (e.g., not turning off lights.), and appliances with poor efficiency, lack of good natural lighting and ventilation, inefficient artificial lighting, and dangerous electrical wiring in the home. While the readyboard technology addresses poor efficiency in lighting, and dangerous wiring, the remaining concerns should be addressed through the regularization and other concurrent programs.

### **Community Engagement Best Practices**

COELBA, a private, investor-owned distribution utility in the Northeastern state of Bahia, Brazil developed a slum electrification program known as Agente COELBA. An excerpt from Innovations in Slum Electrification (USAID, 2002) discusses the format that worked best for communicating:



*Community residents act as COELBA Agents in the community to educate customers about the utility's objectives and to motivate them to conserve electricity and reduce their bills. For instance, the Agents are critical in informing or preparing residents for new initiatives, such as substitutions of incandescent with CFLs, promotions for new refrigerators or other more efficient appliances, etc. The Agents also serve to channel service requests, complaints, problems and other information to COELBA's centralized operations Call Center to improve coordination and reduce time in attending service calls...*

*..One of COELBA's efficiency strategies deployed through its Agent program was to educate customers about energy consumption, opportunities for conservation (e.g., turning off lights, using appliances with high efficiency such as CFLs, utilizing natural lighting and ventilation, etc.), and safety issues (such as dangerous electrical wiring in the home).*

*Participants in educational meetings that were aimed at transforming such customers into "Efficient Customers" were given cards, which, when a sufficient number of stamps recording attendance were obtained, were entered into drawings for new PROCEL-approved efficient refrigerators or other major appliances.*

JPS's community engagement is mirroring many of these techniques by combining the community facilitators, readyboard program, and partnership with JSIF.

Similar approach was taken in Brazil as seen from the following excerpt from Transforming Electricity Consumers into Customers: Case Study of a Slum Electrification and Loss Reduction Project in São Paulo, Brazil (USAID, 2009):

*The pilot design and its components were based on the Partners' ideas about what would make a sustainable approach to slum electrification. The components included:*

- *Upgrades of the distribution system and service infrastructure to make it more difficult to steal electricity and to provide safer, better quality, more reliable and efficient electricity service within the area.*
- *Energy efficiency measures and education to reduce consumption in households and commercial entities and therefore increase affordability of electricity service for the customer, and*
- *In-home safety measures to reduce the risk of electricity related accidents and public lighting to improve the overall ambiance and personal security of the community.*

And continued to discuss community engagement specifics:

*As a first step in the regularization program, AES-Eletropaulo contacted formal and informal community leaders, the municipality, other service providers, such as the water supply company, and NGOs, to inform them about the scope and scale of the planned project and to ensure that the work would be coordinated with the numerous other activities ongoing in the favela...*

*...Door-to-door visits were conducted both pre- and post- regularization to first prepare consumers for regularization before project implementation (to explain the process and allay any fears) and later to assist them to resolve any problems that had occurred during or since regularization. During the visits socio-economic information was gathered. The initial visits preceded the energy audits described below. Community events were also held throughout the process of regularization and afterward, again with a focus on preparing the community for regularization and providing information in an accessible manner about the benefits of regularization, bill paying, controlling consumption by monitoring the meter, energy efficient practices, safety concerns and how to avoid electrical risks.*

*The community-level events were quite useful for completing the registrations of consumers who were not located during the initial registration effort. While the door-to-door visits were indispensable for preparation of the community, the effort was similarly troubled by absences. Numerous extra efforts had to be made to reach as many households as were finally reached, but even then approximately one-quarter was not reached for a pre-regularization visit, and around one-third was not reached for the post-visit. Efforts to contact consumers were abandoned only after four attempts were unsuccessful.*

It is clear from both of these examples, in person meetings and community engagement through community-level events are used as the method of choice for regularizing communities. Additionally, collaboration with multiple partners tends to provide a stronger position for engagement with communities than utilities alone. A focus on safety and energy efficiency also acts as a consistent theme throughout the two examples.

### **Hosting Community Events & Using Community Media**

Community events are advertised through a variety of methods in the communities, ranging from word of mouth, to town-criers, to flyers, to text messages. Depending on the event, combined methods might be used. For example, if the community being engaged is new, it calls for flyers and town crier. For communities that JPS is already well established in, a town crier would not be necessary, instead it is more effective for a facilitator to issue flyers combined with sending out text messages. There is a marked difference in the use of a combination of text messages along with the flyers, rather than just flyers alone.

### **Explaining the Customer Relationship**

The majority of customers become excited and anxious when they perceived they are going to be given something from JPS. Whether it be electricity supply, a tangible product, or even a form of service (skills training, etc) customers will exhibit these feelings.

Conflict with customers arise when it appears JPS is not holding up their end of the bargain. In these cases it seems, from the customers' perspective, that they are being given the run around or are being cheated.

Thankfully, even when these customers are irate, once they are engaged in conversation they tend to listen. It is a good technique to therefore engage customers in the discussions around what may be giving the impression that JPS has not held up their end, or why JPS is in fact no longer able to deliver what they intended to deliver. Despite working closely with disgruntled customers to come to an understanding, there are a few who will remain irate no matter how they are engaged. Thankfully, JPS's relationship on the ground with customers is largely a strong one.

### **Door-to-Door Service**

Door to door services are offered through our community facilitators and Community Relations Officer. Reasons for these visits may include but not limited to: provide updates, to conduct energy conservation talks, conduct energy audits, CDU delivery, etc. These services provide a personal touch for customers, as well as act as a on the ground touch point for the JPS team.

## ELECTRICITY TARIFFS

Electricity tariffs are important because they are an integral component of the amount charged to the end-user. They can vary for type of customer (e.g. residential, commercial, and industrial) and vary according to the time of day the electricity is used (in post-paid meters). In some instances they can vary based on if the customer qualifies for subsidies or a lower tariff class.

This guide will focus mainly on residential tariffs (specifically schedule I) and will not discuss rates for the industrial and commercial classes. The residential rates discussed are accurate as July 5<sup>th</sup>, 2016 as disclosed in JPS Rate Schedules 2016-2017.

### Current Tariff Structure

Schedule I: Rate 10 – Residential Service is the rate class available to all areas of Jamaica and applicable to residential households. As a regulated utility JPS cannot establish its own electricity rates. Residential electricity rates are determined by a range of factors outside the Company's control, most notably the JPS energy rate determined by Office of Utilities Regulation (OUR) and the Fuel & IPP charge representing the cost of fuel and electricity supplied by independent power producers. The details of the rate can be found at [myjpsco.com](http://myjpsco.com).

### Tariff Breakdown

The following sections describe the various components that make up the total electricity tariff charged to an end-user.

### Customer Charge

Independent of whether or not a customer uses any electricity, customers under this rate that are connected to the JPS electrical grid will be charged monthly an amount of J\$429.31. This charge is put towards the underlying costs in providing service to residential customers.

### Energy Charge

Energy charges change based on the level of electricity a customer consumes over the course of a month. There are two different rates, a rate of J\$9.13 for each kilowatt-hour below 100 kilowatt-hours and a rate of J\$21.26 for each kilowatt-hour above 100 kilowatt hours. This charge represents the basic electricity charge as established by OUR intended to exclude costs related to fuel used to generate the electricity and the charges from independent power producers.

### Fuel and Independent Power Producer (IPP) Charge

The Fuel and Independent Power Producer Charge is a monthly charge intended to incorporate the total costs of both the fuel used to generate electricity (including the fuel Independent Power Producers use) and any difference between the costs IPPs incur on non-fuel costs per kilowatt-hour and the costs included in the base Customer and Energy Charges.

Fuel cost is by far the greatest contributor to the Fuel & IPP Charge. JPS requires approximately 20,000 barrels of oil each day to meet the daily electricity demands of customers island-wide. The company must purchase this oil at world market prices which may vary each month. Since 2009, the fuel charge has ranged from a low of 7.626 J\$/kWh April 2016 to 28.828 J\$/kWh March 2014.

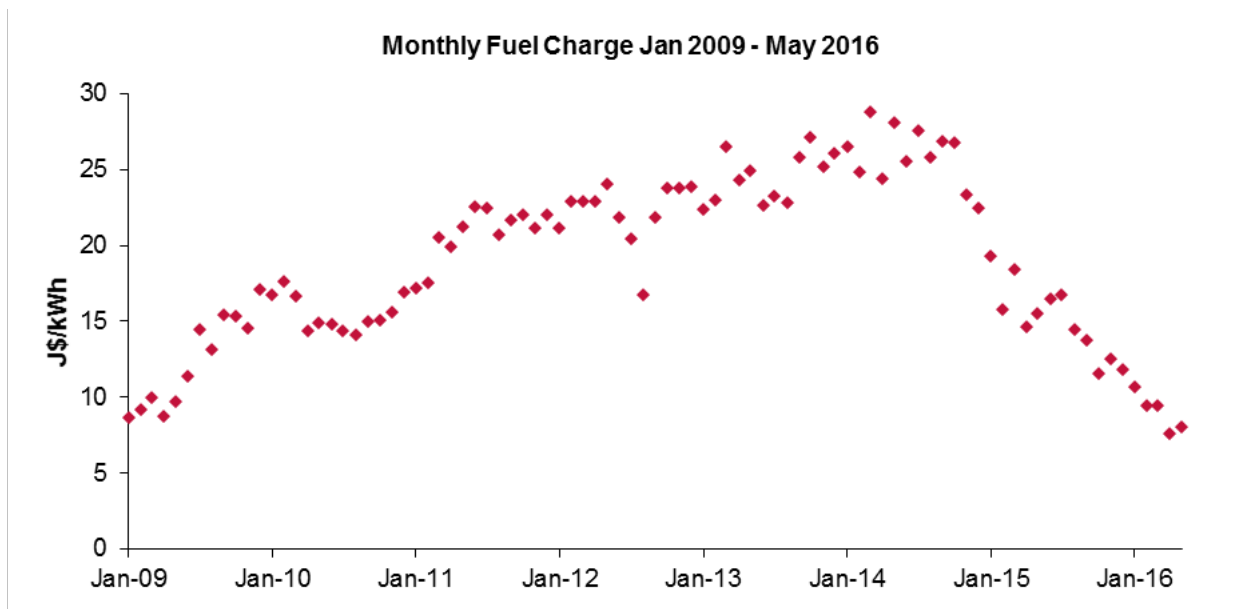

IPPs supply more than one-third of the electricity JPS sells to customers. This portion of the Fuel & IPP Charge however is usually very small – less than one percent.

### Foreign Exchange Adjustment

This item on JPS bills provides adjustments of all charges excluding the Fuel and Independent Power Producer Charge to account for the fluctuations in value of the Jamaican Dollar to the US Dollar. As the value of the Jamaican dollar decreases the adjustment will increase billing rates, and the opposite is true for the increase in value of the Jamaican Dollar.

### Pre-Paid Metering Service

Pre-paid meters are an energy management tool suited for customers who want to manage their energy spend and save money in the process. Additionally, customers can monitor their consumption by checking the local monitor displaying their account information. From the utility’s perspective, meters readings are not required (particularly advantageous for areas such as Majesty Gardens due to safety concerns) as well as improved collections. For these reasons, pre-paid meters will be used in the Majesty Garden’s community. There’s no cost to switch and customers are allowed to switch back for free. The rates for this service are slightly different from the Energy Charge used for meters that are not pre-paid.

There are three different rates, a rate of J\$195.49 for each of the first two kilowatt-hours, a rate of J\$10.08 for the next 98 kilowatt-hours, and a rate of J\$21.51 for each kilowatt-hour thereafter within a 30 day consumption cycle.

### The Electricity Efficiency Improvement Fund (EEIF)

The EEIF is a financial mechanism through which loss reduction strategies are funded with the intention of systematically reducing the electricity losses through the implementation of AMI and other predetermined loss reduction technologies. In order to fund these activities, a rate of J\$0.2499 per kilowatt-hour is charged to residential customers.

### Community Renewal Rate

Oftentimes, utility companies have discounted rates or subsidies for customers that qualify for government assistance and/or have a lower income level. Approved by OUR in their 2015 tariff application has a community renewal rate for customers that meet the requirements of the PATH program. Residents do not to have be enrolled in the program, rather just have to meet the program's requirements listed here. This rate is J\$9.13 for the first 150 kilo-watt hours consumed; consumption above that amount is charged at the standard pre-paid or post-paid rate for residential customers. *Implementation has been delayed as JPS is doing further assessment on the Eligibility criteria.*

## Typical Electricity Bill

How to “Top Up” (Add Credit) on your keypad at home

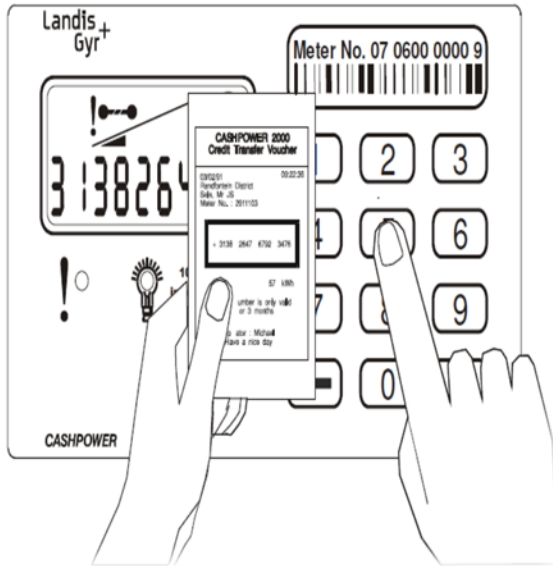

### At Bill Express:

- Provide your PAYG account number (**eg P0000123**) and the name on the account, to the Bill Express Agent
- Present payment for credit at Bill Express
- Receive a printed voucher with a unique 20 digit code from the cashier and a text message with the voucher number
- Punch the unique code on your CIU when you get home

\*If you are making a payment **only** for an advance/**borrowed credit** received, you will receive a receipt **but no voucher number will be included because you will be paying back the loan**

### Typical Results Displayed

		Normal operating mode <i>(Includes zero credit and supply disconnected)</i>
		Number not recognized by meter
		Number already used
		Not enough digits entered <i>(30-second timeout)</i>
		Meter Tampered
		Service callout
		Number expired
		Service callout

## Bill Express Voucher when Customers Receive Credit

.....:BILL EXPRESS:.....

Mandeville FSC  
 Brumalia Town Centre, 2 Perth Road  
 Mandeville  
 11-Oct-2016 05:00 PM

TELLER : NATDWYER  
 RECEIPT # : 247351616101100161215

-----

Acc. Holder: ~~XXXXXXXXXX~~7

Billers : Jamaica Public Service- Prepaid Electric  
 Acc. Number: p0000790  
 Service Type: Prepaid Voucher  
 Voucher #: 04566787597100219513  
 Units: 64.2 kWh  
 Bill Amount: 2500 JMD @1

.....:PAYMENTS:.....

Method : CASH  
 Amount : 2,525.00 JMD @1.00

Bill Total : 2,500.00  
 Service Fee: 21.46  
 Tax : 3.54  
 Total Due : 2,525.00  
 Tendered Amt: 2,600.00  
 Change: 75.00

Thank you for using our services. Please keep this receipt in a safe place

## Bill Express Voucher Reprint/Online Voucher

The diagram shows a voucher reprint with the following fields and callouts:

- Rep processing transaction:** Points to the Transaction field.
- Purchase date/Reprint details:** Points to the Transaction date and type (DUPLICATE/ORIGINAL).
- Customer name, details and account #, class etc.:** Points to the Account field.
- Details of purchase per kWh rate:** Points to the Meter field.
- Value of purchase in dollars:** Points to the Total field.
- kWh/FX price details:** Points to the breakdown of charges (Electric, Fuel, Foreign Exch).
- PIN (20 digit voucher#):** Points to the PIN field.

Account:	P0001030 Richard Priestly
Transaction:	cmccormack arrears 32385 DUPLICATE: 2016-Aug-15 15:13 ORIGINAL: 2016-Aug-15 09:33
Account:	P0001030 Richard Priestly 1A Milverton Crsn Monr RT10-PAYC_BY 60045301/1
Tariff:	07120088369
Meter:	1649 1803 2255 7655 9862
2.0 kWh @ 195.4900 =	\$ 390.98
23.2 kWh @ 10.0800 =	\$233.80
Electric: 25.2 kWh	\$624.78
Fuel: 14.2250kWh	\$358.06
Foreign Exch : 2.6 %	\$ 16.56
<b>Total:</b>	<b>\$1000.00</b>

(Voucher reprint can be requested at any JPS office)



Point of Sale “Top Up” – JPS is in discussions and is preparing to launch point of sale top up. Customers will soon be able to purchase credit at any location with a GO Machine) eg gas station, shop, supermarket, vendor. Sending the text message is FREE.

## Point of Sale Voucher

Partner Logo (Facey Commodity/Transactions E-Pins)

JPS PAYG logo

Vendor details, date & time

PIN (distinguished from voucher# )

Go 12-digit voucher #

Value of purchase in dollars

Instruction including #s to send text to (999-4JPS, FLOW); 552-4JPS, Digicel)

Instructions for assistance – call [center information](#)

Serial # (can be used by Customer to redeem via call [center](#) if messaging fails)

JPS | Home  
RE-IMAGINING ENERGY... TOGETHER

# HOW TO SAVE MONEY AND STAY SAFE

## Electricity Basics

Electricity is the flow of electric charge from one point to another, creating light, powering televisions, and cooling buildings. Electricity is generated at power plants through the consumption of fuel (oil, natural gas, coal, wind, sun) and delivered to consumers via transmission and distribution lines.

From a consumer perspective there are two key measurements to understand when thinking about electricity, **watts** and **watt-hours**.

**Watts** are a measure of how fast the flow of electricity is moving, and higher watt measurements indicate faster flow of electricity, also known as power. An incandescent bulb using 75 Watts (or W abbreviated) has a much higher flow of electricity than a LED lightbulb using 12 W.

**Watt-hours** are a measure of how much electricity flowed over a given amount of time, and takes into account both how fast the flow of electricity was (W) and how long it was flowing for (hours). When a watt of power is used for an hour that measurement is called a watt-hour, and is a measurement of energy. JPS charges based on kilowatt-hours (kWh), or 1,000 watt-hours, used in a given period.

$$\text{watts} * \text{hours} = \text{watt} - \text{hours}$$

Both the watt and watt-hour are critical for a consumer to understand given the implications the measurements have on energy efficiency and the customer's energy bill. **Minimizing the number of watts when purchasing an appliance** is one of the main tenants of energy efficiency, as it will minimize the amount of electricity customers would use with that appliance.

The other tenant to energy efficiency is **limiting how long appliances are used**. A common example is turning lights off when one is not in the room, as it is an attempt to minimize the amount of time while power is flowing.

## Energy Efficiency, why is it important?

Energy efficiency from the consumer perspective has both short term and long term benefits. The short term benefits are the most tangible to the customer since energy efficiency leads to decreased monthly electricity bills, allowing customers to recognize their efforts on a monthly basis by influencing disposable income. In the long term, ignoring energy efficiency may lead to increased electricity rates as JPS invests in new electricity generation assets. While JPS may acquire and produce new generation remains in line with current costs, as demand grows pressure may be placed on the electrical supply making it more likely JPS will acquire and produce more expensive electricity. To recover the increases in cost, JPS may ask for increases in tariff prices leading to more expensive electricity bills for residents and businesses.

Outside of the customer's direct purview, there are also societal benefits to promoting and investing in energy efficiency. For example, since energy efficiency can decrease the amount of power being drawn from the grid, in the long term it curbs demand and can limit the number blackout events experienced by customers. Additionally, every electricity consumer has a role to play in being aware their consumption has an effect on the production of greenhouse gasses as well as other environmentally damaging waste products. Maintaining low electricity prices through energy efficiency can have broad reaching positive societal effects on energy access and affordability, employment, public budgets, resource management, health, and even the value of properties that have strong energy performance.

## Peak Hours

While these rates are not for residential customers currently, the tariffs illustrate the increase in demand during work hours and evenings. All else being equal, when demand increases for electricity the price will increase to deter use as supply is limited. Moving electricity usage to partial-peak or off-peak hours can help to keep operating costs low and prevent further increases to tariff prices in the future. Additionally, energy efficiency techniques are particularly important during on-peak and partial-peak times as the potential savings increase with the price of electricity.

In Jamaica electricity time-of-use increases prices during on-peak and partial peak times compared to off-peak periods. On peak hours are defined by 6:00pm – 10:00pm Monday through Friday while partial-peak hours are 6:00am – 6:00pm Monday through Fridays as well as weekends and public holidays 6:00pm to 10:00pm. Off-peak hours are 10:00pm – 6:00am as well as weekends and public holidays all other hours than 6:00pm – 10:00pm.

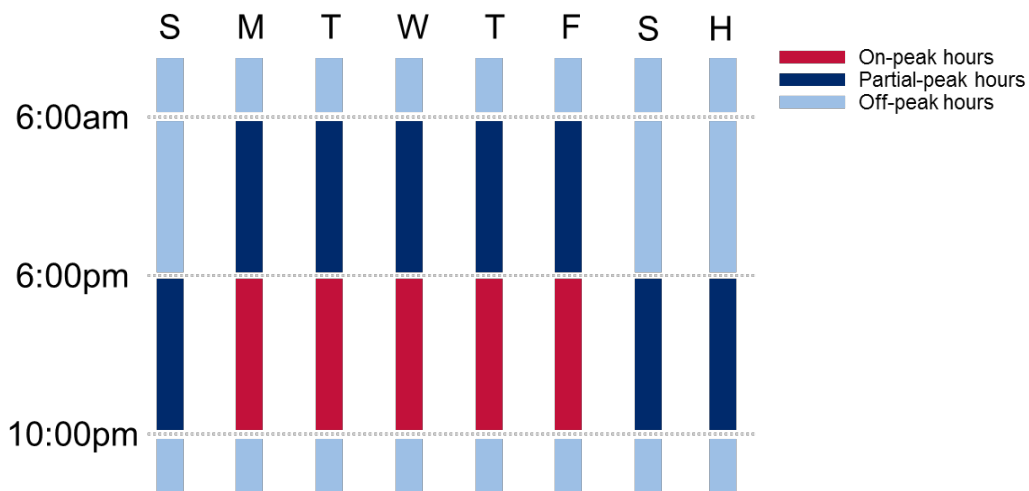

During these times, electricity used has a premium added to the standard charge representing roughly an increase of 56% for on peak, 44% for partial-peak, and 4% for off-peak (with slight differences between tariff schedule IV and V).

### Basic Energy Management Techniques

The first step in understanding and improving energy management is first knowing how an individual or organization is using energy. Knowing how energy is being used allows those looking to reduce their use of electricity to identify the habits which are driving their electricity consumption. Taking inventory of all of one’s electrical appliances, or at least the 2 or 3 highest electrical consumption appliances, paired with some estimates as to how long those appliances use power can help determine the main drivers of electricity consumption.

Once the main drivers are determined, there are a variety of techniques that can be used to reduce consumption (a full list of key energy efficiency tips can be found in Appendix A):

- **Lighting:** Replacing standard (incandescent) bulbs with compact fluorescent light bulbs or LED bulbs can significantly reduce the amount of energy used by lighting. Additionally, using light colored lamp shades or placing lights in room corners can increase the brightness of a room allowing fewer lightbulbs to be used. For an average resident in Majesty Gardens, switching to LED lights can cut electricity bills by 50%, or J\$400 per week.
- **Cooling:** Installing blinds with light colors can reflect heat from the sun, as well as painting the tops of homes shades of white.

- **Appliances:** Older refrigerators (greater than ten years old) can require far more electricity than current models, particularly if the fridge is much larger than what is required for daily use, and replacing the older model for a newer version can save significant amounts on energy bills.
- **Electronics:** Even when electronics are turned “off” they may be in a standby mode which still draws electricity. Unplugging power chargers, TVs, laptops, stereos, and most other electronics when not using them can reduce energy use while in standby mode. If a power strip is available, plugging electronics into this power strip and turning the strip off when not using the electronics can be a quick way of avoiding standby use.

## Energy Consumption Calculations

### Wattage

Wattage is the measurement of power being used by appliances, and can be found on appliance labels or included in any instructions provided with the appliance. More often than not if the wattage cannot be found with the appliance or packaging, an internet search of the product can yield the wattage. Wattage is indicated with a number labeled with a capital ‘W’, typically accompanied by a measurement of the voltage the appliance should be used at (indicated by a capital ‘V’) and the phase of the electricity (indicated by Hz). When determining the energy consumption of an appliance the voltage and phase can be ignored if the wattage is present and the appliance is being operated at the indicated voltage and phase.

This wattage amount is typically the amount that is drawn from the electrical grid when the appliance is turned on/in use. Some consumer appliances draw power even when turned off or not in use, and an internet search for the product in question can typically determine what amount of power is being used in these standby modes. A good rule of thumb is to disconnect appliances from wall sockets that are not being actively used to ensure that no power is being drawn.

### Time

The amount of time an appliance uses electricity constitutes the time used for the purpose of energy calculations.

It is an important distinction that the time used for the energy calculations is not the amount of time a consumer is interacting with the device, since as previously discussed many household devices such as fridges, freezers, and common electronics will use electricity while the consumer is not actively engaged with the appliance (ex. standby mode). Similar to determining how much wattage a device uses in standby mode, the amount of time an appliance draws power in standby mode can be found on product information websites.

### Kilowatt-Hours

Kilowatt-hours can be calculated by multiplying the wattage of an appliance by the amount of hours the appliance was used at that wattage (active use and standby wattage and hours should be done separately). Summing the total kilowatt-hours across all appliances creates an overall energy consumption for a given set of appliances, be those belonging to an individual, family, community, company, or other group.

# METERING ELECTRICITY AND USING A READYBOARD

## Service Drop

A service drop is the term used for the electrical line typically running overhead (underground the term is service lateral) from the utility pole to the point where JPS provides power to customers. More often than not the electrical meter, which records the amount of electricity consumed, is located on the end of a service drop just before the customer's house wiring begins. Since readyboards are analogous to house wiring, they are installed after the electrical meter and are outside the domain of JPS.

## Meter Types

### Post-paid

Post-paid meters represent the traditional method for billing customers for electricity, allowing customers to consume electricity on credit and requires payment by the end of the month. JPS tariff rates for post-paid meters are slightly lower than those for pre-paid methods.

### Pre-paid

Instead of paying at the end of the month after the customer has already created a debt to JPS as in post-paid structures, pre-paid metering allows users to pay ahead of time only for electricity that they would like to consume. The pre-paid structure allows for the removal of monthly bills, elimination of credit collection, and can be paid for through the customer's mobile phone. While customer charges are slightly higher with pre-paid services, the added benefits can more than compensate for the added cost to the customer.

Pre-paid metering systems have clear benefits for low income communities and other customers in Jamaica. Jamaicans who earn on an irregular basis can pay when they earn, and customers can reduce costs by closer monitoring of consumption. Landlords no longer absorb the debts of their tenants and community centers can transfer the responsibility of electricity costs to the users of their facilities.

## Readyboard Basics

Readyboards are small, inexpensive, and self-contained household wiring units for the provision of basic electricity service. A manufactured readyboard is connected to the electricity distribution system through a meter (pre-paid, in this case) and contains protective breakers, one or more electricity outlets, lightbulb sockets, and a trouble light. A number of countries have employed readyboards as one solution for effectively metering low-income urban and rural dwellings across the world, including South Africa, Kenya, and Nepal.

## Components

### Lights

The lights installed along with the Readyboard come in two arrangements, a light affixed to the support board and a trouble light (with its own switch) that extends further from the board. Both lightbulbs are 13W LED lights, producing the equivalent light of a 75W traditional lightbulb. The estimated lifespan of the light is roughly 10 years, compared to an approximate 6 months of a traditional lightbulb.

This is the most energy-efficient types of lighting possible and will result in a much lower cost of electricity (i.e. allow residents to use the pre-paid electricity credit for longer).

### Light Switch

There is a light switch provided with the Readyboard intended to turn off the light attached to the readyboard as well as the trouble light. The light switch and indoor light fixture are supplied by a 15 Amp breaker.

### Breaker

The readyboard is connected to the JPS system through a 30-Amp breaker and prepaid meter. Two smaller branch breakers are provided to supply plugs and the light switch.

### Outlets

Four plugs have been provided and are connected to a 20-Amp breaker that provides overload and shock protection to extension cords and appliances and entertainment devices. Homeowners must make sure they are using appropriately-sized and safe extension cords.

## Installation

- Identify customer
- Conduct structural integrity checks to determine strongest and most suitable wall
- If additional strengthening of wall is required then 2" x 6" lumber is affixed to the wall
- Mount ready board and stanchion, install grounding, wires and conduit
- Submit for GEL inspection

The steps towards installation and electrification are as follows:

- Residents sign up to become JPS customers
- Homes are inspected
- Contractor installs ReadyBoard at the premises;

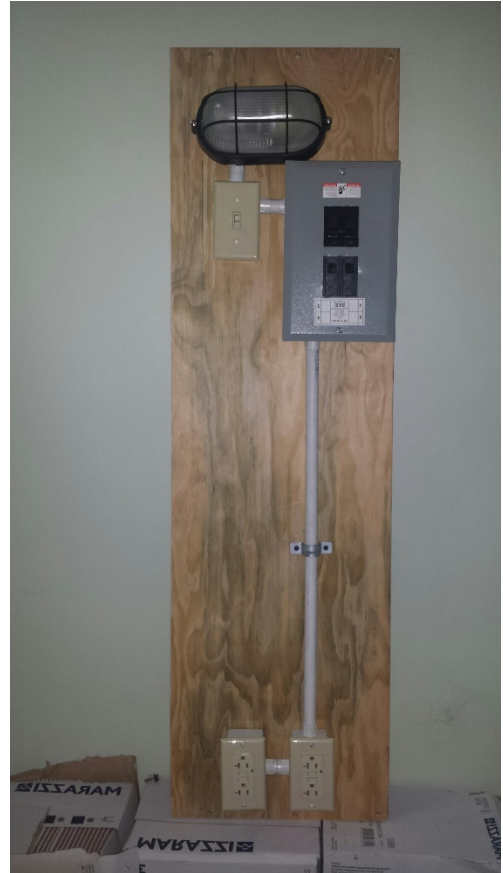

- Inspection is carried out by the Government Electrical Inspectorate (GEI)
- Once units are passed, JPS electrifies the ReadyBoards
- JPS removes illegal wires

## Device Compatibility

The outlets on the Readyboard function identically to the outlets found in traditional wiring installations. All devices compatible in traditional wiring installations are compatible with the Readyboard installation.

## Safe Use

- A. The main switch (30 Amp Breaker) is provided in order to protect the entire Readyboard from overload. The need to use this switch is very unlikely, most Readyboard owners will never use this feature. However, if a problem does arise with the main switch or it activates after resetting then residents should seek a qualified electrician.

**What do I do if the switch marked “30” (1) is in the “Off” position?**

Flip the switch into the “On” position. If the switch goes back to the “Off” position after having already switched it to the “On” position, call a qualified electrician.

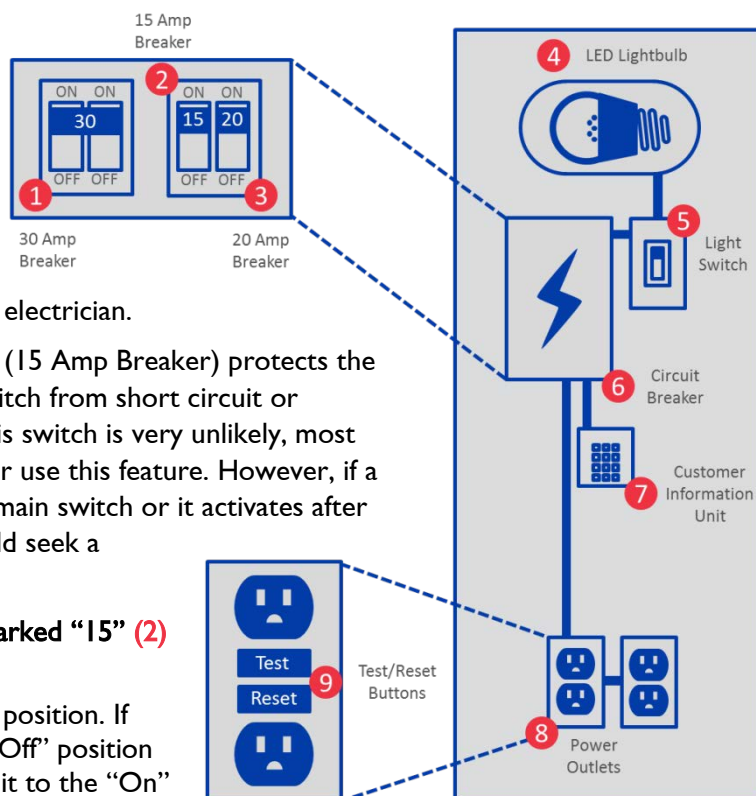

- B. The switch that is marked 15 (15 Amp Breaker) protects the Readyboard light and light switch from short circuit or overload. The need to use this switch is very unlikely, most Readyboard owners will never use this feature. However, if a problem does arise with the main switch or it activates after resetting then residents should seek a qualified electrician.

**What do I do if the switch marked “15” (2) is in the “Off” position?**

Flip the switch into the “On” position. If the switch goes back to the “Off” position after having already switched it to the “On” position, call a qualified electrician.

- C. The switch that is marked 20 protects the plugs and the extension cords and connected appliances from overload. If an excessive number of appliances are plugged into the outlets, this switch will automatically go to the “Off” position. Some appliances or devices need to be unplugged before turning the switch back on.



**What do I do if the switch marked “20” (3) is in the “Off” position?**

Flip the switch to the “On” position. If it goes back to the “Off” position after having already switched it to the “On” position, then unplug some appliances or other devices and flip the switch to the “On” position. If the switch goes back to the “Off” position after having switched it to the “On” position a second time, call a qualified electrician.

- D. The plug with the Test/Reset Buttons (9) monitors all appliances and extension cords for ground faults. It also protects users from electric shocks due to faulty cords or appliances. If the plug opens (the circuit is broken) it will not be visible to the resident with the exception of loss of power to the plugs with continued functionality of the lights. The defective equipment should be unplugged and the plug can be reset.

**What do I do if there is no power at my plugs (8), but my light (4) works?**

Unplug appliances and devices and press reset button (9) on the first plug. The appliance with the fault should be repaired or replaced.

- E. System power outages may happen or all customers on one defective transformer may be affected.

**What do I do if there is no power at my plugs (8) and light (4)?**

Check that all switches are in the “On” position. Check with your neighbors to see if they have light or if it is a JPS outage. Report local system outages to JPS.

- F. The Bulb will eventually burn out.

**With all switches “On” I do not have light, what is the issue?**

If all switches are on and there is power at the plugs (8), then the light bulb (4) is burned out. Purchase and install a replacement LED bulb.

- G. The homeowner can replace the bulb.

**How do I replace the light bulb (4)?**

Remove the two screws holding the front cover on by using a flat screwdriver. Unscrew the defective bulb, install a new one, and reinstall the front cover.

The Light Bulb should be 13 Watt, LED Type, Shape A19.

Before buying a new bulb, check to see if there is any warranty on the burned out bulb.

- H. The GFCI should be tested periodically.

**Why is there a test button (9) on one of my plugs (8)?**

To check that it is working to protect people from electric shock, it should be tested once a month. After pressing the test button (9) all appliances and devices will be without power. Press the reset button (9) to restore power to plugs.

- I. Outlet Safety

As residents transition to plug-in electricity, it should not be assumed that safety measures used to protect against shock are common knowledge. The GFCI is designed to protect people from severe or fatal electric shocks, but it cannot guarantee safety in the event of tampering. Only electrical appliances and extension cords should be inserted into the plugs, and outlet plugs (plastic cover to prevent the inadvertent insertion into the plug) should be used to prevent inadvertent tampering.

### Can I put other items besides electrical cords into the plugs (8)?

No, inserting anything but an electrical cord is dangerous, particularly to young children unaware of the dangers of electrical shock. When outlets (8) are not being used, it is recommended that plugs (8) (plastic inserts for the outlets) are used to prevent inadvertent tampering. Additionally, all members of a household should be educated on the potential hazards of inserting non-electrical cables into the plug (8).

#### J. Extension Cord Sizes

##### What extension cord should I use?

Use heavy duty extension cords for tools and appliances such as fridges and irons.

*Light duty extension cords can be used for lamps and entertainment equipment.***How to Get Help**

### JPS Community Facilitators

JPS Community Facilitators are located and can be accessed at JPS Service Centres located in the Community Renewal Communities. Their office hours are from 8:30am to 4:00pm Mondays to Fridays, however because a lot of what they do are in the field, they may be a way from the office for extended periods. As such, a note is left on the door, advising of their time expected return time

### Frequently Asked Questions

#### Where do I buy credit?

Customers can buy credit at selected Bill Express locations.

Bill Express	Bill Express Location	Parish
Auto Tech	59C Waltham Park Road Kingston 11	Kgn & St. Andrew
Barbados FSC	19-23 Barbados Ave	Kgn & St. Andrew
Boulevard FSC	Boulevard Super Centre, Shop #7, 45 Elma Crescent Kingston 20	Kgn & St. Andrew
Central Sorting Office-(PO)	South Camp Road, Central Kingston	Kgn & St. Andrew
Constant Spring PO	Constant Spring, St Andrew	Kgn & St. Andrew
Cross Roads FSC	13 Old Hope Road Kingston 5	Kgn & St. Andrew
Cross Roads PO	Cross Roads, St Andrew	Kgn & St. Andrew
General PO (King Street)	King Street, Central Kingston	Kgn & St. Andrew
Grants Pen PO	Grants Pen, St Andrew	Kgn & St. Andrew

<b>Half Way Tree PO</b>	Half Way Tree, St Andrew	Kgn & St. Andrew
<b>Harbour View Football Club</b>	Cnr. of Fort Nugent Drive & Harbour Drive, Kingston 17	Kgn & St. Andrew
<b>JPS - East Parade</b>	7-9 East Parade, Kingston	Kgn & St. Andrew
<b>JPS - Ruthven Road</b>	23 Ruthven Road, Kingston	Kgn & St. Andrew
<b>King Street FSC</b>	Woolworth 83 King Street Kingston	Kgn & St. Andrew
<b>K's Pharmacy</b>	Shop 17 Duhaney Park Plaza, Kingston 20	Kgn & St. Andrew
<b>Lawrence Tavern PO</b>	Lawrence Tavern, St. Andrew	Kgn & St. Andrew
<b>Liguanea PO</b>	Liguanea, St Andrew	Kgn & St. Andrew
<b>Meadowbridge PO</b>	Meadowbridge, St Andrew	Kgn & St. Andrew
<b>Mona PO</b>	Mona, St Andrew	Kgn & St. Andrew
<b>Panoramic Traders - Brooklyn</b>	Brooklyn Supermarket 11 Hope Road Kingston 10	Kgn & St. Andrew
<b>Paper Gold Ltd. - Barbican</b>	Shop 1A Orchid Village Plaza 20 Barbican Road Kingston 6	Kgn & St. Andrew
<b>Paper Gold Ltd. - Cross Roads</b>	Shop 14, State Mall 15-17 Half Way Tree Road Kingston	Kgn & St. Andrew
<b>Parkview Supermarket - Papine</b>	7 Chandos Place Papine, Kingston 6	Kgn & St. Andrew
<b>Pavilion FSC</b>	Shop #30, Pavilion Mall, 13 Constant Spring Road, Kingston 10,	Kgn & St. Andrew
<b>Stony Hill PO</b>	Stony Hill, St. Andrew	Kgn & St. Andrew
<b>True North Ventures Ltd. - Pechon Street</b>	7 Pechon Street, Kingston	Kgn & St. Andrew
<b>UTECH PO</b>	University of Technology, Hope Road, St. Andrew	Kgn & St. Andrew
<b>Vineyard Town PO</b>	Vineyard Town, St Andrew	Kgn & St. Andrew
<b>Western District PO</b>	Western District, St Andrew, Kgn 20	Kgn & St. Andrew

**How do I know when I'm getting low on credit?**

The customer unit inside your home will show you the number of kilowatt hours you have left and will also give you a warning when have 5 kwh left

**What happens if something goes wrong with my readyboard?**

The customer have to engage a licensed electrician to determine the fault and to do the necessary trouble shooting and effect the required corrective measure.

**How do I replace the light?**

When your credit runs out (to zero) you will lose your light. You can purchase credit and top up or you can call the JPS customer care center at 1-888-225-5577 (1-888-CALL-JPS) for an advance if at that time you are unable to top up

**How can I get a copy of my bill?**

Prepaid customers do not receive a bill. They receive a statement instead. The customer can visit any JPS office and request a print out. For customers with an email address, JPS can send the statement to them via email

**What is in the Participation Letter?**

The participation letter outlines the terms and conditions of participating in the prepaid pilot programme

**How were the recipients chosen?**

All customers whose homes cannot take the conventional house wiring are eligible to apply. When the applications are taken, it will however be the first four hundred who pay the required fees, who will benefit

**What if my house floods; am I at risk?**

There is always a risk with any electrical installation, however the readyboard is fitted with GFCI protected outlets will provide help to mitigate against the possibility of electrocution in the event of a flood.

**Can the board be re-used if I am moving to the top section?**

Possibly, however preparations would have already been made up there to facilitate regular connection, as the idea behind the ready board is for structures not weak enough to take the conventional house wiring.



**Can I leave it at the location if someone else wants to use it?**

Yes, however you would decide the kind of arrangements you would make for same.

**What about the money I have paid? Would I get it back if I no longer need the board?**

The contribution is just that – a small contribution in comparison to what the real cost is to make the board; it is non-refundable. Your security deposit of \$1500.00 is however refundable on termination of your contract with JPS. It is applied to whatever balance is on the account and if there is none, you can apply for the security to be refunded.



## Appendix A: Promotional Materials

		
\$\$\$	\$\$	\$

Even though a low price at the store, standard incandescent lights will cost far more over their lifetime than CFL or LED bulbs. Buy LED bulbs to make the lowest electricity bill!



Lights should be turned off during the day or whenever they are not needed. Don't pay for electricity you don't need, turn off your lights when you are not in the room!

	
--	---

		
\$\$\$	\$\$	\$

Smaller refrigerators use less energy to operate. Consider your family's needs and buy the right-sized refrigerator!

Newer refrigerators use far less electricity than older models. Make sure to change older models to save money on electricity bills!

<b>2006</b> 	<b>2011</b> 	<b>2016</b> 
\$\$\$	\$\$	\$

Opening a refrigerator can let out the cool air and make the appliance draw more electricity to keep food cold. Cut down on the trips to the fridge and save on your electricity bill!

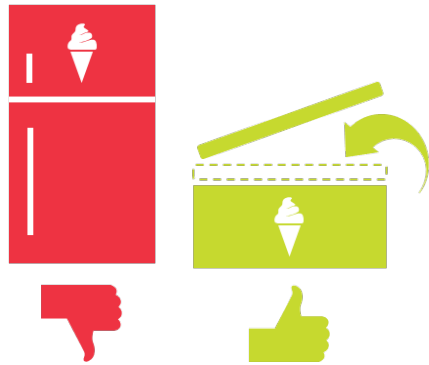
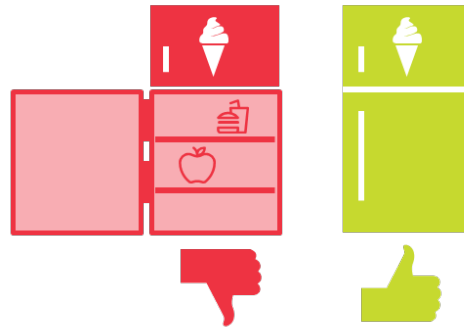

A deep freezer generally uses 10-25% less energy than an upright model. If you need another freezer, a deep freezer can save you on your electricity bill.

Larger TVs use more energy than smaller models. Make sure you think about the ongoing costs of a larger television!

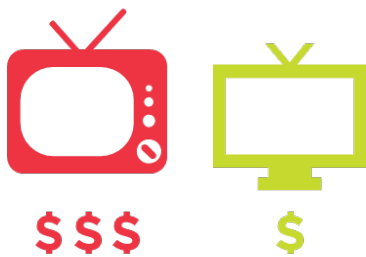
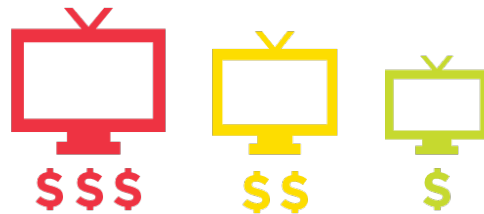

“Big back” TVs use a lot of energy compared to newer, flat screen TVs. Upgrading your TV can lower your electric bill!

Set water levels to reflect the amount of clothing being washed. Electricity is saved with less water to heat!



Top loading washing machines use more electricity than front loading machines. Make sure to buy a front loading machine to save on electricity bills!



Be sure to turn off fans and irons when not in use, as the electricity they use will be wasted. Keep electricity payments low by cutting down use!

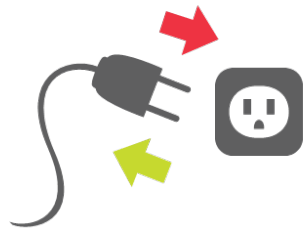

Plug-in appliances use electricity even when not in use. Make sure you plug-out appliances when they are not in use!

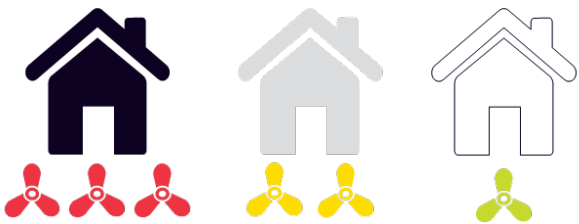

Light colors cut down the amount of taken in by buildings during sunny days. Be sure to paint your houses white to save on cooling costs!



Fans should direct wind across a room to ensure hot air is sent out of the building. Make use of cross breezes to improve the effectiveness of your cooling!

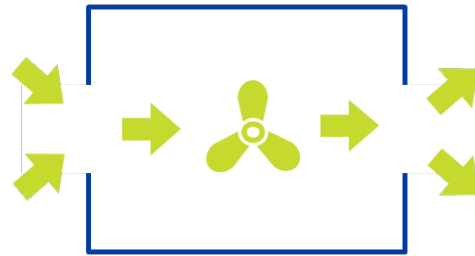

**WHO DO I CALL IF I WANT TO TALK TO SOMEONE ABOUT MY PRE-PAID METER?**

Our friendly Customer Service Representatives (CSRs) are standing by 24/7 at 1-888-CALLJPS (235-5577) / 1-888-935-5577 and are eager to assist you with any Pay As You Go meter support you may need

**WHAT IF THE PREMISES I MOVE INTO ALREADY HAS A PRE-PAID METER?**

If there is an existing PAYG meter on the premises, it is our hope that you would give the service a try. Simply indicate to the JPS representative that you would like to try the service when processing your new contract.

**WHAT IF I AM A PRE-PAID CUSTOMER AND I AM CHANGING LOCATIONS?**

Once your new location can accommodate a PAYG meter we will install the service. Your JPS customer number remains the same. When you sign your new contract, your old account at the previous premises will be closed and you will be assigned a new Pre-paid account number.

**WHAT IF PAY AS YOU GO IS NOT FOR ME?**

98% of customers currently on PAYG report being extremely satisfied with the service. If the PAYG service does not suit your needs, it is free to switch back to Post-paid service within the first 12 months.

There are so many convenient ways to top up your Pre-paid Meter



**AT GO POINT-OF-SALE LOCATIONS**

1. Purchase \$300, \$500, \$1000 or \$2000 PAYG credit at any GO point-of-sale vendor
2. You will then receive a printed GO voucher with top up instructions and a unique 12-digit code from the cashier
3. IMMEDIATELY follow the instructions to text your PAYG account number (900000\*) and the 12-digit GO voucher number to any of the mobile numbers provided
4. You will receive a text message with your 20-digit PAYG voucher number
5. Enter the unique code on your customer interface unit (CIU) when you get home



The bill payment place from **Grad-Kennedy** **CDLI** **EXPERIENCE**

**AT BILL EXPRESS:**

1. Provide the account number and the name on the account to the Bill Express Agent and present payment
2. Receive a printed voucher with a unique 20-digit PAYG code from the cashier and a text message with the voucher number
3. Punch the unique code on your customer interface unit (CIU) when you get home.

\*If you are making payment only for an advance received, you will receive a receipt, but no voucher number will be included

**SKIP THE LINES AND GO ONLINE**

1. Visit [www.njpsco.com](http://www.njpsco.com) and register your pre-paid account for bill payment
2. Enter your customer number, premises number and email address, then follow the instructions to register your credit card
3. Once you have registered, you may begin the process of purchasing pre-paid electricity
4. Enter the amount you want to purchase and follow the instructions to complete the process
5. Once completed, you will receive a text message (and an email message) with your 20-digit PAYG voucher number
6. Enter the unique 20-digit voucher number on your customer interface unit (CIU) at home

**That's it!**

The total power available will be immediately reflected on your display unit!

For faster service, please have your unique PAYG Account Number ready when going to buy credit, and remember to check your receipt to ensure that the information is accurate.



**PRE-PAID Metering:**  
An easier way to lower your electricity costs.

NO BILLS, NO DISCONNECTIONS,  
AVAILABLE ISLANDWIDE.

JPS | RE-IMAGINING ENERGY... TOGETHER



**WHY CHOOSE A PAY AS YOU GO METER?**

Pay As You Go (PAYG) also known as Pre-paid Metering, is one way JPS is helping our customers to manage their energy consumption, you asked for choices and with the PAYG meter, you literally control how much you pay.

**WHAT ARE THE BENEFITS OF SWITCHING TO A PRE-PAID METER?**

- No bills!
- No reconnection fees!
- Payment flexibility – Top up when you want with how much you want.
- Convenient and easy top-up!
- No Deposit required!
- Monitor and control how much electricity you use at any time.



**There's an easier way to lower your electricity costs**

You could spend 35-50% less on electricity

**CAN ANY JPS CUSTOMER SWITCH TO A PAY AS YOU GO METER?**

PAYG meters are available to JPS Home (Residential) and JPS Business (Small Commercial Rate 20) customers. Islandwide, customers in areas served by the RAKI system and customers whose meter is more than 300 feet from the building are not eligible for a Pre-paid meter at this time.

**DO I HAVE TO CHANGE MY METER TO MAKE THE SWITCH TO PAY AS YOU GO METERING?**

Most customers will require a new meter. Customers recently upgraded to a Smart Meter can enjoy the flexibility of Post-paid or PAYG service without a meter change.

**HOW DO I CHANGE FROM POST-PAID TO PAY AS YOU GO METERING?**

<b>STEP 1</b>	Visit any JPS office, go online to <a href="http://www.mnjpsco.com">www.mnjpsco.com</a> or contact our Customer Care Centre (1-888-225-5577 / 1-888-935-5577) and request the change.
<b>STEP 2</b>	A technician will visit your premises and conduct an assessment to verify that you can receive the service.
<b>STEP 3</b>	Once you are verified, your existing Post-paid account will be converted to a Pre-paid account. Your meter is then installed with \$1kVn free.

**AM I LIKELY TO ENCOUNTER AN INTERRUPTION IN SERVICE WHEN I MAKE THE SWITCH FROM POST-PAID TO PRE-PAID?**

It can take as little as 20 minutes to replace the old meter. During this time, your service will be briefly interrupted. Total installation time will depend on the layout of your premises and the distance between the meter and the building.

**WHERE DO I PURCHASE CREDIT FOR MY PRE-PAID METER?**

Credit can be purchased at any of our fifteen parish offices, online at [www.mnjpsco.com](http://www.mnjpsco.com), or at over 150 participating Bill Express locations across Jamaica. Customers may also use point-of-sale top ups via GO terminals.

**CAN MY PRE-PAID METER RUN OUT OF CREDIT WITHOUT WARNING IN THE MIDDLE OF THE NIGHT OR ON A WEEKEND?**

There is no risk of running out of credit without warning. The meter alerts you when you have \$1kVn remaining - approximately 1 days' worth of electricity for an average household, providing ample time to top up your account.

**WHAT HAPPENS IF I RUN OUT OF CREDIT AND I NEED TO TOP UP?**

No problem! Just call our Customer Care Centre at our toll free number (1-888-225-5577 / 1-888-935-5577) and we will extend a \$500 advance to you. The value of the advance will be deducted from your next top up.



**Get a real time view of your electricity usage**

**SOMETIMES I NEED A LIGHT BILL AS PROOF OF ADDRESS. WHAT WOULD I DO IF I GO ON PAY AS YOU GO?**

As a PAYG customer you will NOT receive monthly bills. However, you can request a copy of your PAYG statement from any JPS office, which can be used as proof of address.

**JPS** | RE-IMAGINING ENERGY... TOGETHER